



ALPHA

CHAIR STAIRLIFT

ALPHA

The superstar of chair stairlifts provides a versatility of design and aesthetic to compliment any interior. Create your own personalised stairlift from our broad range of materials and finishes.

Classic Line



- High quality fabric
- 6 options of fabric colour
- Armrest from robust plastic

Premium Line



- Wooden upholstered frame
- 6 options of fabric colour
- Armrest from imitation wood

Exclusive Line



- Armrest crafted from nutwood
- 9 options of fabric and colour
- Adjustable backrest

Rail colour:



Choose from the **standard colours RAL 7035 and 9007** (optionally any RAL colour is possible).

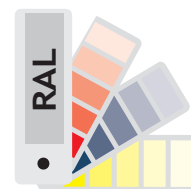

Flexible installation, flexible design!

The Alpha stairlift eliminates the barrier of stairs by providing safe and easy access to other floors. This stairlift has been designed for installation on stairs with a curve, intermediate landings, or even when discreet out-of-the-way parking is required. The Alpha stairlift features a reliable double rail system for both strength and durability.

Alpha is easy to operate by controls on the armrest and by two additional radio frequency remote controls. Through accurate photo measuring and computer-aided design, all our rails are custom-bent to the exact specification of your stairs. Just choose the ideal seat and rail colours for Alpha to perfectly complement the interior design of your home.

Try the Alpha configurator

here



Company founder Max Lehner

Alpha Classic Line To match any taste

- Upholstery fabric is available in 6 colours
- Seat and backrest are completely covered with fabric
- Rail system can be painted in any RAL colour



Seat and backrest are covered with fabric on both sides



By pressing a **swivel seat lever**, the seat can easily be turned at the landing stations



The **robust armrests** provide stable support for one's whole body weight



In the resting position, the armrests, seat and footrest can simply be folded up, which guarantees **minimum space requirement at the entry and exit area**

Comfort, convenience and safety are the Alpha's top priorities

6 different seat fabrics are available to choose from in the Classic Line:

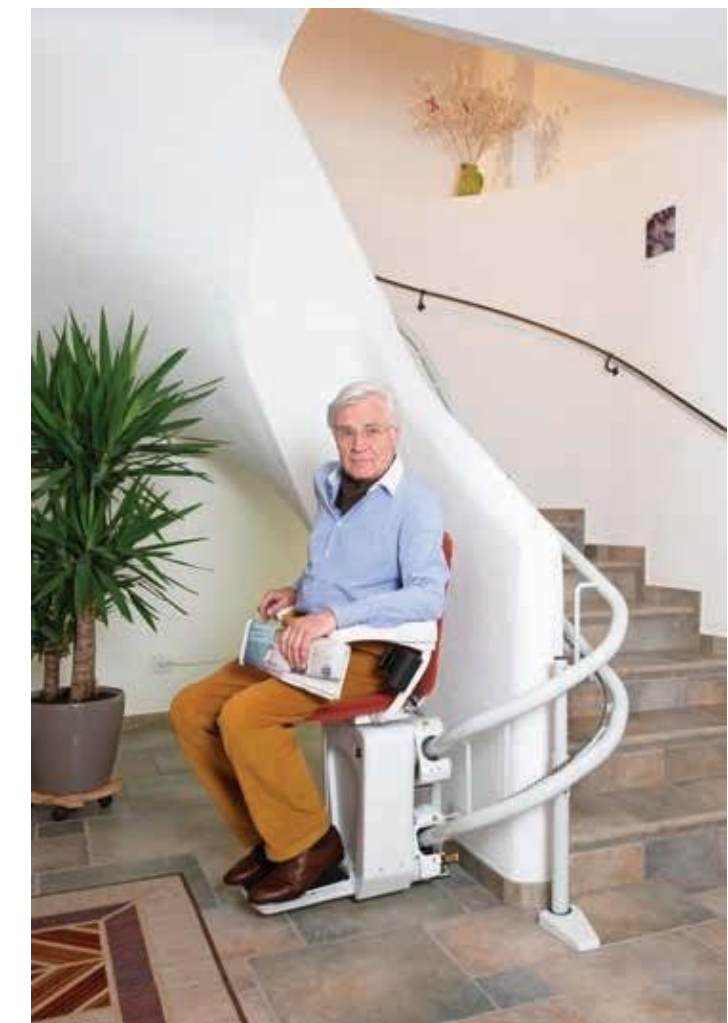

Alpha Premium Line Especially special

- 6 colours of fabric are available to personalise the upholstery of your stairlift
- Wooden seat and backrest are available in 2 different wood colour tones
- Rail system can be painted in any RAL colour
- Lower part of the armrests is robust ABS plastic



Seat, backrest and armrests are available in **2 wood colour tones**



The **rounded seat edges** ensure optimal comfort during the ride



Armrests made from imitation wood to perfectly match it with the wood tone of the seat and backrest



The Alpha stands for **robust functionality and refined aesthetics**

The **selected seat colours** can be perfectly combined with the **different wood colour tones**

6 different seat fabrics from artificial velours leather are available to choose from in the Premium Line:



2 different wood colour tones can be combined with the selected seat colours:



Alpha Exclusive Line Elegance par excellence

- 9 individual colours of high quality fabrics are available to personalise the upholstery of your stairlift
- Seat, backrest and armrests are hand-crafted from noble nutwood
- Rail system can be painted in any RAL colour
- An adjustable backrest provides extra comfort during the ride



Seat, backrest and armrests are hand-crafted **from noble nutwood**



Rounded seat edges and high quality processed fabrics



Detail of the hand-crafted armrest with **integrated lift control**

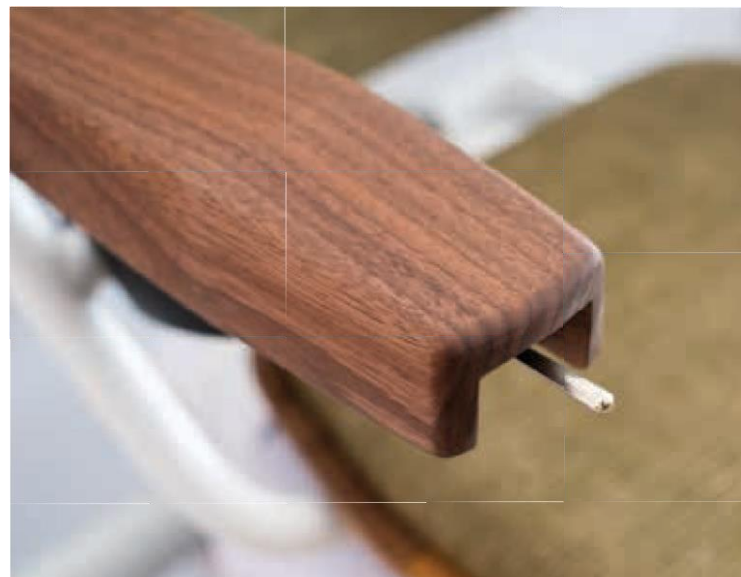

Highest quality and performance thanks to professional craftsmanship and selected materials

9 different seat fabrics from either artificial leather (AL) or woven textiles (WT) are available to choose from in the Exclusive Line:



Exclusive materials make this lift a high-end and durable piece of furniture for your home



Main advantages of the Alpha stairlift

- 1 **Silent, stable and smooth riding quality** guaranteed by the slim twin tube rail system
- 2 **Great variety of colours and designs** for the seat and armrests
- 3 **Motorised folded footrest** as an option, either activated with seat board or switch in armrest
- 4 **Motorised swivel seat** as an option for easy embarking and disembarking the lift
- 5 **Alternative mounting options** such as wall-, string- or clamp-mounting
- 6 Navigation of the lift by **joystick**
Ergo-joystick ^{6a} available on request
- 7 **Automatic folding rail** as a solution for narrow hallways and doors
- 8 **Outdoor usage** possible through technical adaptations of seat, drive and rail
- 9 Reliable **radio remote controls** with great reach for operation over several floors
- 10 **Maximum safety** due to pull-in safety belt and contact sensors according to EN 81-40

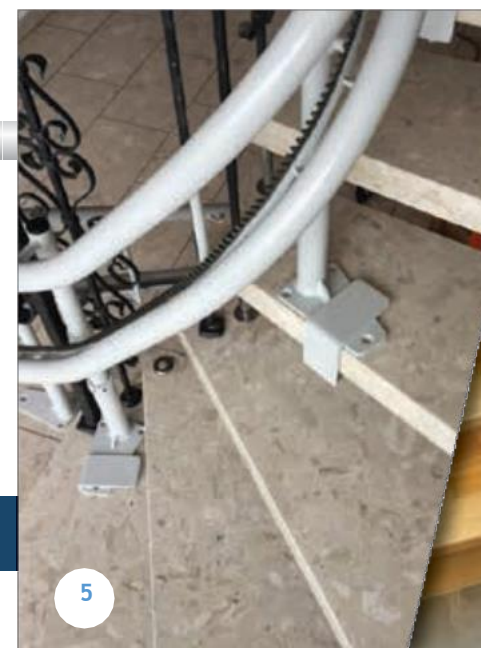

Alpha – Technical Specification

Loading capacity	130 kg (optional 145 kg)
Drive system	Rack and pinion
Motor	24 V DC, battery driven
Possible gradient	0 – 52°
Speed	0.06 – 0.12 m/s
Max. rail length	35 m
Noise level	Under 50 dB
Temperature	+45°C to -15°C
Power supply	1 × 230 V / 50–60 Hz
Certificate	 TÜV certified to EN 81-40

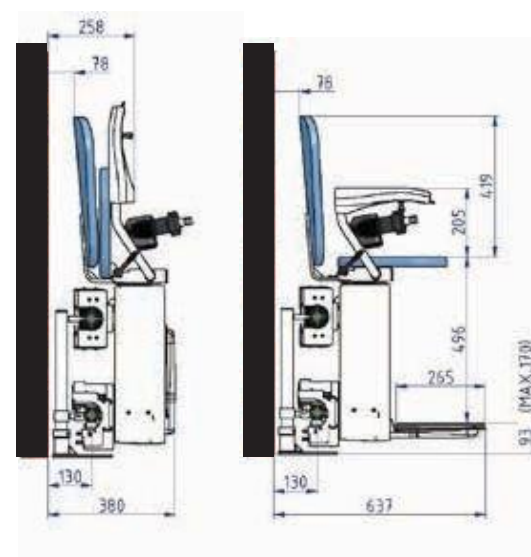

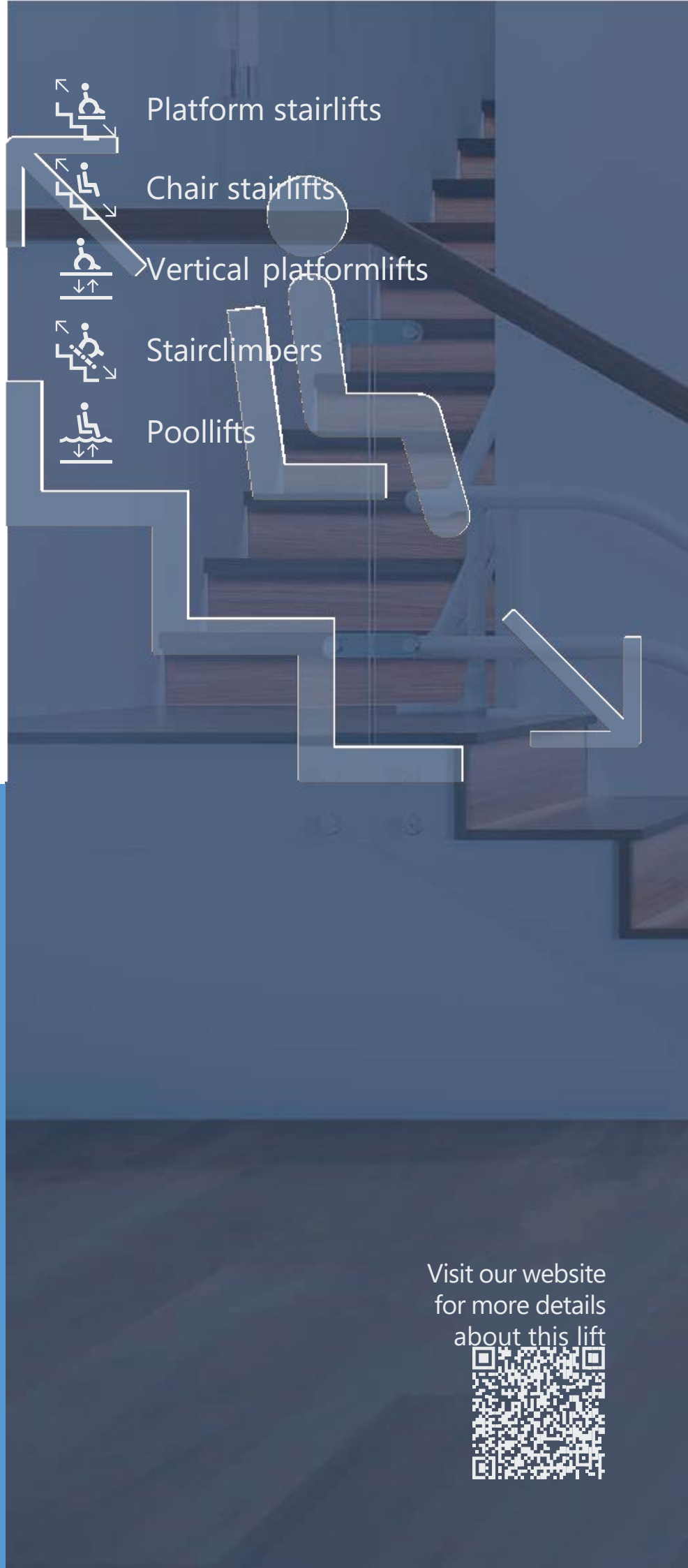

Platform stairlifts

Chair stairlifts

Vertical platformlifts

Stairclimbers

Poollifts

Contact your dealer for further information:

ALTITUDE
LIFTS 

 **1300 844 427**

 sales@altitudelifts.com.au

 www.altitudelifts.com.au

 Gngara Showroom open by appointment

Official partner of:



Visit our website for more details about this lift

